



Instruction Manual

BT010 Bluetooth® Speaker



Thank you for purchasing HamiltonBuhl's BT010 Bluetooth® Speaker. Before getting started, please read the user's manual carefully to ensure proper operation and optimize performance. This unit not only offers a stylish appearance, but its compact design offers high fidelity sound.

Function Buttons

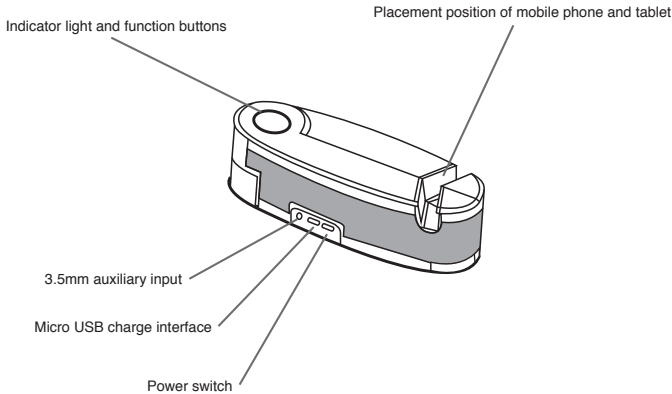

Power on the Unit

When power is turned on, the speaker makes a “click-click” sound and the Bluetooth® indicator light will start flashing.

Connecting Bluetooth®/ NFC:

NOTE:

Some devices may need to remove protective cover before using.

Turn on the Bluetooth® function on your device. If connecting the NFC (Near Field Communication) enabled devices, make sure to turn on the NFC function in the devices. If the function is available, turn NFC on. Push the power switch on and move the device close to the “NFC” logo on the speaker (BT010). The device will automatically pair with the speaker.

If your device does not support the NFC function, turn on the Bluetooth® speaker (BT010) then go to the Bluetooth® setup menu from your device. When BT010 becomes available in the Bluetooth® device search mode, select BT010 and pair it manually. Bluetooth® indicator light will flash slowly after a successful connection, and the speaker will make a “toot” sound.

If BT010 fails to detect any Bluetooth®-enabled devices within five minutes after power is turned on, the Bluetooth® function will turn off automatically. In order to re-establish the Bluetooth® connection, it is necessary to turn the BT010 power switch off and turn it back on again. The Bluetooth® devices that were connected successfully before will connect automatically when BT010 is activated again.

If connection fails, please power off the device and power it back on and make sure the unit is charged.

BT010 Product Specifications

- Bluetooth® V4.0
- Transmission Distance: ≤10M (depending upon operational environmental and source devices)
- USB Recharge Voltage: DC 5V/1050mA
- Built-in Lithium battery
- Charge Time: 4-6 hrs
- Output Power: 5W×2
- Frequency Response: 90Hz-20KHz
- Sensitivity: 80dB±2dB
- Signal to Noise Ratio (SNR): ≥76dB
- Dimensions: 9.5" x 2.4" x 1.6" (240 x 62 x 41 mm)

Compatibility

Wireless: Devices configured with Bluetooth® V2.1+EDR or higher version such as iPad™, iPhone™

Troubleshooting

Problem	Solutions
Unable to pair up with devices	<ol style="list-style-type: none"> 1. Turn off BT010 and turn it back again to search any Bluetooth®-enabled devices. 2. There are too many Bluetooth® devices in the proximity that cause difficulty in connection. Please turn them off.
The sound is low or distorted	<ol style="list-style-type: none"> 1. Check the connected Bluetooth® enabled device's volume level and adjust it to proper level. 2. Recharge the battery.
The sound stops from time to time	<ol style="list-style-type: none"> 1. Check the distance between BT010 and the connected Bluetooth® enabled device is within a proper operational range. If not, move the sourcing device closer to BT010. 2. Avoid any obstacle between BT010 and the sourcing device (e.g., wall, large furnitures, etc.)
The Bluetooth® indicator remains off	<ol style="list-style-type: none"> 1. Low battery, please recharge the unit



What's in the Box

- One BT010 Bluetooth® Speaker
- One USB Power Cable
- Instruction Manual





Using the device is strictly prohibited when the mobile phone is charging, the consequences of improper use may cause damage to the device.

Bluetooth® Music Playback





Press and hold “” to pause during playback; Press “” again to play.

Hands-Free Calls

After connected with the mobile phone successfully, the speaker will beep when a call comes in. Press  to answer the call and talk. No need to pick up the phone. Press  again to hang up the call. To refuse a call, hold down the button. Double click on “” button to redial the last phone number at Bluetooth® connection state.

AUX Playback

Insert audio cable into AUX input of BT010 from your source devices then the AUX indicator will light up.

1. For AUX playback press “ ” to pause and press “ ” again to resume sound.
2. The speaker will turn off automatically after 5 minutes without a connection. To reactivate BT010, use the On/Off switch to turn it back on gain.

Charging

Insert the Micro USB end into the USB power jack of the speaker. Connect the opposite end to a computer USB port or USB charger. The charging indicator light will be off after charging is complete.

Precautions

Please store and use this product at the room temperature; Do not expose this product to the rain or damp surroundings; Dismantling or modifying this item in any way, voids the warranty;

Product Registration Instructions



Visit: www.HamiltonBuhl.com

1. Click on Customer Care
2. Click on Product Registration Icon
3. Please fill out all fields marked with * to register

Warranty:

Warranty begins the date item ships from our warehouse. All products, except for metal carts, have a one year warranty from original date of shipment, unless otherwise noted. Metal carts have a limited lifetime warranty on all housing components; however, carts have a one year warranty on any electrical / mechanical components.

Our Mission:

Since our founding in 1933, HamiltonBuhl continues to evolve as a leader in technology products for education and industry. Our products are embraced by educators, corporate trainers, presenters, government agencies, and hospitals for their daily presentation, from the classroom to the boardroom, HamiltonBuhl has the presentation product for you.